

## Protecta Range

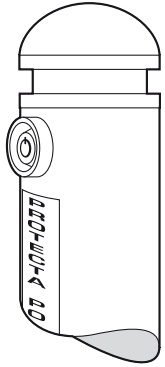

Option Cap 20.00

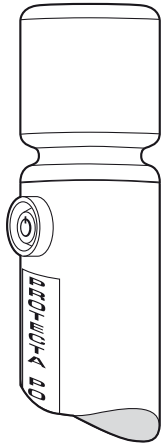

Option Cap 80.01

All stainless steel locking system with lock cylinder protector.

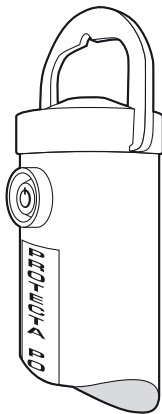
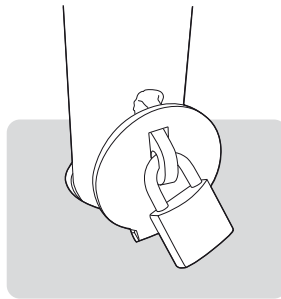
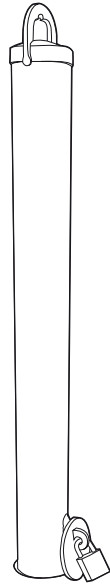
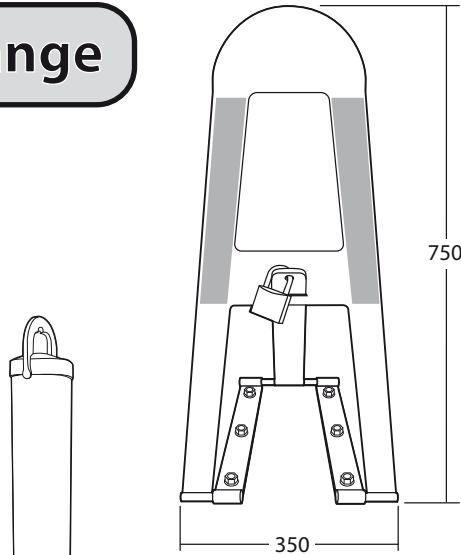

Inground sleeve with cover plate

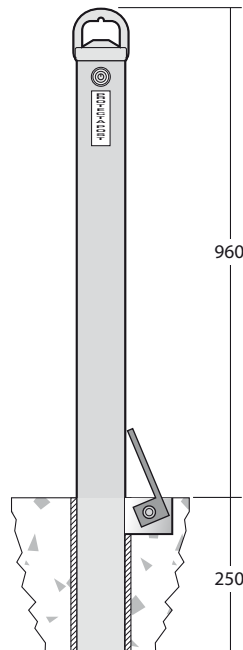

### Price Excludes GST

**Important:** Ensure installation and maintenance are properly executed to obtain maximum performance, efficiency and durability from your Lighthouse product.

**Disclaimer:** While every care has been taken with the details on this specification sheet Lighthouse Bollards & Caps accepts no responsibility for any inaccuracies. Lighthouse Bollards & Caps also reserves the right to change these specifications without notice to always ensure that you are receiving a superior product.

**Lighthouse Bollards & Caps**  
 579 Warrigal Rd, Ashwood 3147  
 Mobile Phone: 0412 406 960  
 Fax: 61 3 9885 7768  
 Phone: 03 9885 8684  
[www.lighthouse-bollards.com](http://www.lighthouse-bollards.com)  
 Australian owned company

## Protecta Park

### SPECIFICATIONS

#### Description

Protects against unauthorised use of parking space which folds flat for access.

#### Material

Heavy duty construction 8mm steel zinc plated. 50mm reflective strips.

#### Height

750mm in locked up position.  
 Folds down to a 30mm low profile.

#### Weight

10kg

#### Locking

Padlock optional

#### Installation

Easy installation into most surfaces with 6 anchors supplied.

## Protecta Post/Padlock

### SPECIFICATIONS

#### Description

Heavy duty padlock operated removable bollard designed for ram raid protection.

#### Material

Steel post 90mm diameter with 6mm wall thickness.

#### Height

960mm above ground  
 250mm below ground

#### Weight

Post 12kg  
 Sleeve 3.5kg

## Protecta Post

### SPECIFICATIONS

#### Description

Heavy duty key operated removable bollard post designed for ram raid protection.

#### Material

Steel post 90mm in diameter with 6mm wall thickness.

All stainless steel locking system.

#### Height

960mm above ground  
 250mm below ground

#### Weight

Post 15kg  
 Sleeve 3.5kg

#### Locking

High security stainless steel locking system with lock cylinder protector.

#### Installation

Core drill or new concrete footing  
 'In ground' sleeve supplied.

#### Finish

Zinc plated prior to powder coating  
 Standard colour 'Safety Yellow' other colours on request.

#### Options

Two matching caps can now be fitted to keep all bollards uniform.  
 Post holder for storage of idle post.  
 Keyed alike locking.